

# *RAMPART-A* *Project Overview*

1 October 2010

TOP SECRET//COMINT//NOFORN

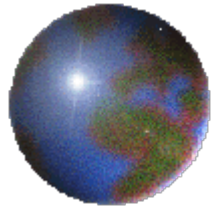

*This briefing is classified*  
***TOP SECRET//COMINT//NOFORN***

TOP SECRET//COMINT//NOFORN

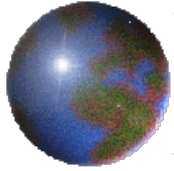

# *RAMPART-A Overview*

- ⊕ Covername for NSA's unconventional special access program
  - ⊗ to gain access to high-capacity international fiber-optic cables that transit at major congestion points around the world.
  
- ⊕ Program started in 1992 with the establishment of the National Fiber Optic Program Fund
  - ⊗ Four initial global congestion points identified
  - ⊗ Extended Bi-lat partnerships w/FAD to new compartmented efforts
  
- ⊕ General agreements negotiated:
  - ⊗ Foreign Partners provide access to cables and host US equipment
  - ⊗ US provides equipment for transport, processing, & analysis
  - ⊗ No US collection by Partner and No Host Country collection by US
  - ⊗ Shared tasking & collection
  
- ⊕ Today....
  - ⊗ 5 on-going relationships
  - ⊗ 2 cooperative relationship (w/ RAM-T)
  - ⊗ 2 emerging relationships

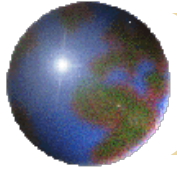

## *Project Description*

- ❖ (TS//SI) RAMPART-A's accesses target long-haul leased communications through international gateways. Circuit-Switched and Packet-Switch signals are enabled by foreign partners. Collection and Processing assets reside on foreign soil and traffic is exfilled back to NSA.
- ❖ (TS//SI) Access Types: International Gateway Switches; End-Point GSM Switches; Leased Internet Circuits; Internet Backbone Routers; Call Records.
- ❖ (S//SI) Every Country Code in the world is seen at one or more RAMPART-A collection accesses

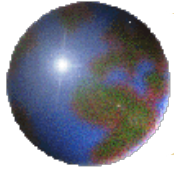

# *SSO/RAMPART-A Site Operations Model*

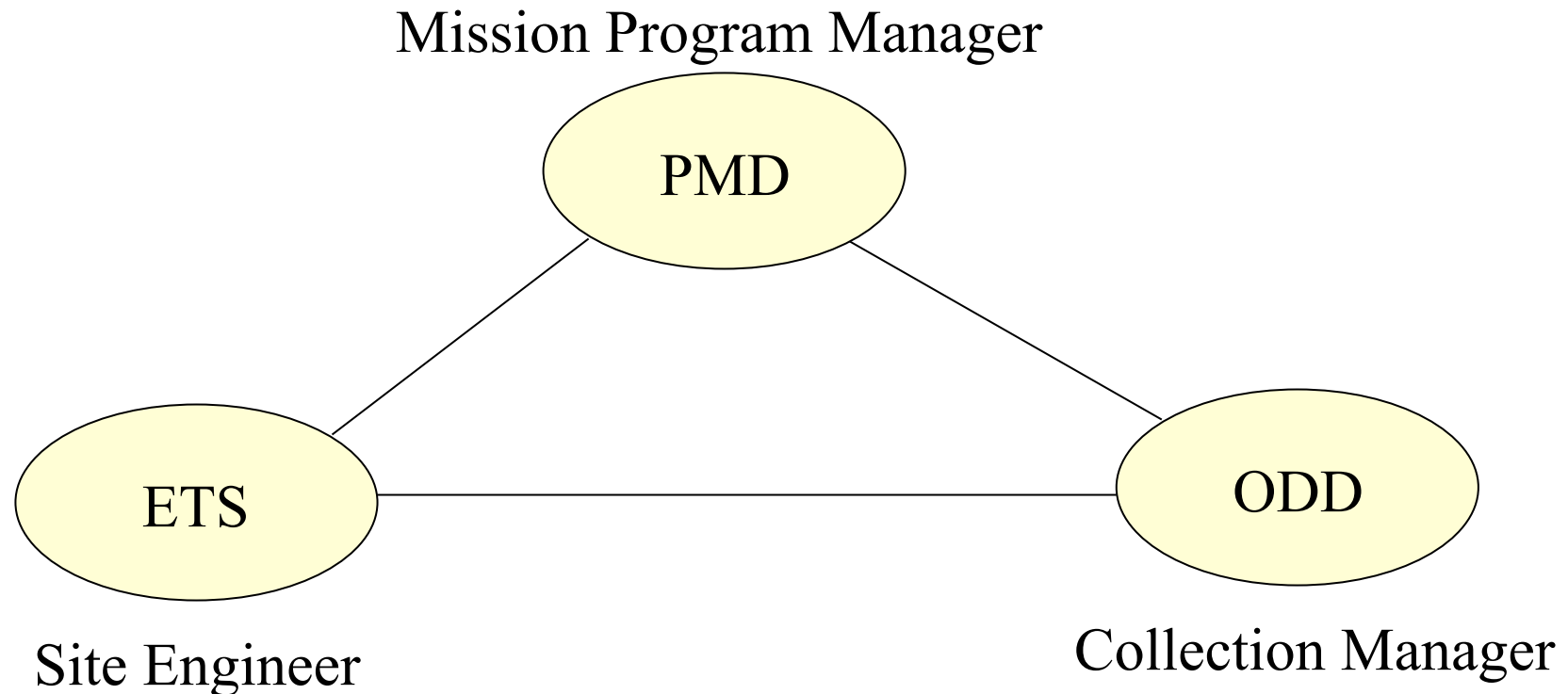

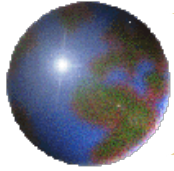

# *Engineering and Technical Services (ETS)*

- ⊕ (U//FOUO) Integrate corporate and commercial solutions
  - ⊕ **In compliance with differing Third-party architectures**
- ⊕ (C) Test end-to-end integrated solutions to meet SSO & Third-party operational requirements
- ⊕ (C) Deploy and support new systems to Third-party controlled facilities

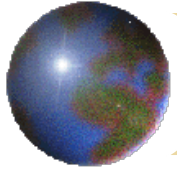

# *Operations and Discovery Division (ODD)*

- ⊕ (C) Responsible for the tasking of the collection systems
- ⊕ (C) Coordinates system resources with the RAMPART-A partners
- ⊕ (C) Analyzes communications links to optimize collection resources
- ⊕ (C) Monitors the performance of the collection systems

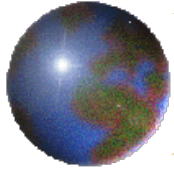

## *RAM- A Projects*

- ⊕ **US-3237/SMOKYSINK** (no 3<sup>rd</sup> party partner/joint RAM-T)
  - ⊕ **DNR & DNI**
- ⊕ **US-3127/AZUREPHOENIX**
  - ⊕ **DNR & DNI**
- ⊕ **US-3180/SPINNERET**
  - ⊕ **DNR & DNI**
- ⊕ **US-982/TRANQUIL – Retired June 2010**
  - ⊕ **DNR & DNI**
- ⊕ **US-3145/MOONLIGHTPATH**
  - ⊕ **DNI & DNR (September 2010)**
- ⊕ **US-3190/FIREBIRD**
  - ⊕ **DNR & DNI**
- ⊕ **US-3153/FALCONSTRIKE**
  - ⊕ **DNR & DNI**
- ⊕ **US-3178/DULCIMER**



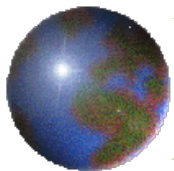

# *RAMPART-A Typical Operation*

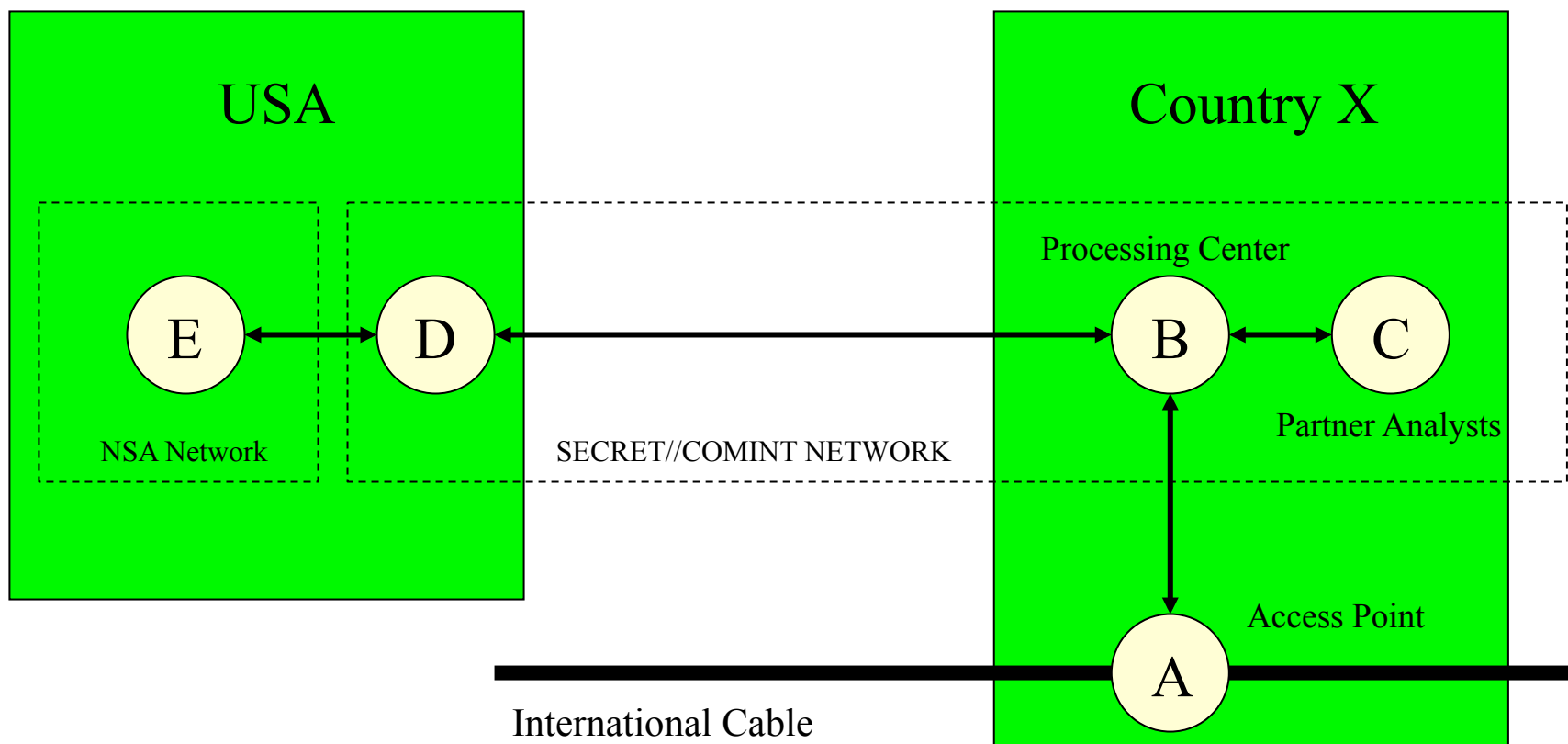

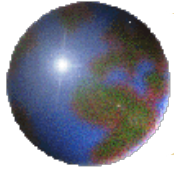

# *Sensitivity Factors*

## ⊕ **(TS//SI//NF//ECI) Compartmentalization**

### ⊕ **REDHARVEST/RDV**

- Who is the partner
- Where is the access
- What is the access

## ⊕ **(TS//SI//NF) Cover**

- ⊕ Most RAMPART-A Third-party partners work the fiber projects under the cover of an overt Comsat effort

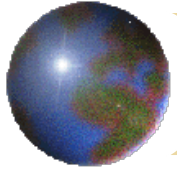

# Capabilities

## ⊕ (TS//SI) Capabilities:

- ⊞ Automated, Continuous, High-Speed Survey of Circuit and Packet Switched Traffic
- ⊞ Packet-Switched selection & session collection
- ⊞ Dial Number Recognition of Circuit-Switched telephony

## ⊕ (S//SI) Deploy, and continually upgrade Circuit and Packet Switched collection architecture to all RAMPART-A sites

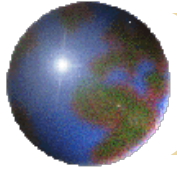

## *SIGINT Value Added*

- ❖ (TS//SI) Product Lines: All A&P product lines use collection from RAMPART-A for SIGINT reporting
- ❖ (TS//SI) Productivity/Intelligence gains: Over 9,000 SIGINT Product Reports written last year with ~49% being Single Source Reports
- ❖ (TS//SI) Targets within Accesses: International voice & fax telephony; Users of “web services” (e.g. –Port 80 e-mail; Chat; VoIP); GSM; Calling Card users

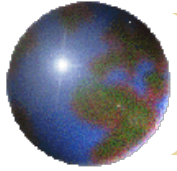

# *SMOKYSINK*

- ⊕ (TS//SI) SMOKYSINK is in "steady state" mode
- ⊕ (TS//SI) Continuous TU upgrades

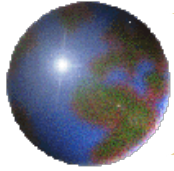

# *AZUREPHOENIX*

- ❖ (S) Site Physical Plant Upgrade  
2010-2011
- ❖ (TS//SI) TU deployment earliest Spring  
2012?
- ❖ (TS//SI) Partner working on additional  
accesses

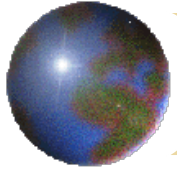

## *SPINNERET*

- ❖ (TS//SI) Cables upgrading with additional capacity – RAM-A deploying additional resources to accommodate
- ❖ (TS//SI) 60 Gbps LPT – October 2009
- ❖ (TS//SI) Additional 60 Gbps LPT scheduled for late 2010

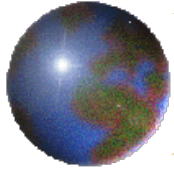

## *MOONLIGHTPATH*

- ❖ (S) DNI system deployment – April 2009
- ❖ (TS//SI) New Cable access survey – May 2009
- ❖ (S) Site B rehab – Winter 2009
- ❖ (TS//SI) **New access in Sept. 2010**
- ❖ (TS//SI) New DNR/DNI system deployment – first phase (DNR) in May 2010. DNI to follow TU deployment schedule



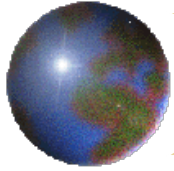

# *TRANQUIL*

⊕ (TS//SI) TRANQUIL shut down in  
June, 2010



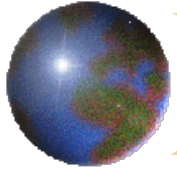

## *FIREBIRD*

- ❖ (TS//SI) Unique 3<sup>rd</sup> party enabled access – no NSA processing systems
- ❖ (TS//SI) Collection System IOC – February 2010
- ❖ (TS//SI) Working to establish an NSA to 3<sup>rd</sup> Party partner collection system translation

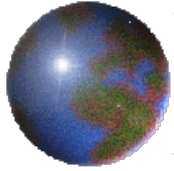

## *FLASHMARK*

- ❖ (TS//SI) Access same as FIREBIRD, but allowing US Collection Systems
- ❖ (TS//SI) Survey – March, 2010
- ❖ (TS//SI) FIREBIRD/FLASHMARK issue to be resolved this month.

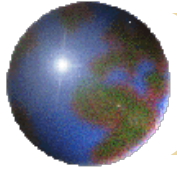

# *FALCONSTRIKE*

- ✦ (TS//SI) Survey – September 2009
- ✦ (TS//SI) Pilot System Deployment – January 2010
- ✦ (TS//SI) Secure Comms Deployment – January 2010
- ✦ (TS//SI) Two Track Future
  - Sustained system – mid 2012
  - Pilot System upgrade completed – December 2010

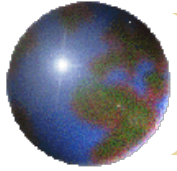

# *DULCIMER*

- ⊕ (TS//SI) Survey – November 2010
- ⊕ (TS//SI) Expected traffic should be large international internet pipes

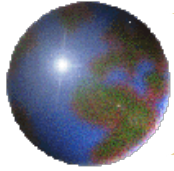

# *CONDORSPEAK*

- ❖ (TS//SI) Discussions with Partner – October, 2010
- ❖ (TS//SI) Expected initial traffic will be metadata from target cable

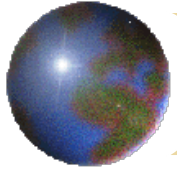

## *In Summary*

- ❖ RAMPART-A has access to international communications from anywhere around the world
- ❖ SSO/RAMPART –A stands ready to support your intelligence gathering needs